

IEC Appliance Inlet C14 with Fuseholder 1- or 2-pole



Screw-on mounting



Snap-in version



Fuse holder "Fingergrip" with voltage selector



See below:
[Approvals and Compliances](#)

Description

- Panel mount :
 Screw-on version from front or rear side, snap-in version front side
- 3 Functions :
 Appliance Inlet Protection class I , Fuseholder for fuse-links 5 x 20 mm
 1- or 2-pole , with or without voltage selector (step switch)
- V-Lock notch standard
- Meets the requirements of IEC 60335-1 for appliances in unattended use. This includes the enhanced requirements of glow wire tests acc. to IEC 60695-2-11 or -12 &-13.
- Quick connect terminals 4.8 x 0.8 mm

Unique Selling Proposition

- Very compact design
- Components internally wired
- Integrated voltage selector
- V-Lock cord retaining

Characteristics

- Available with or without internal connections
- Plug removal necessary for fuse-link replacement
- Suitable for use in equipment according to IEC/UL 62368-1

Other versions on request

- With solder terminals
- Fuse drawer with other voltage values
- For protection class II

References

Alternative: version with line filter [KFA](#)

Weblinks

[pdf data sheet](#), [html datasheet](#), [General Product Information](#), [Approvals](#), [Distributor-Stock-Check](#), [Accessories](#), [Detailed request for product](#)

Technical Data

Ratings IEC	10A / 250VAC; 50Hz	Appliance inlet/-outlet	C14 / C18 acc. to IEC 60320-1, UL 498, CSA C22.2 no. 42 (for cold conditions) pin-temperature 70 °C, 10A, Protection Class I
Ratings UL/CSA	10A / 250VAC; 60Hz	Fuseholder	1-/2-pole, Shocksafe category PC2 acc. to IEC 60127-6, for fuse-links 5 x 20mm
Dielectric Strength	> 3kVAC between L-N > 4kVAC between L/N-PE (1 min/50Hz)	Rated Power Acceptance @ Ta 23 °C	5 x 20: 2W (1 pole)/ 1.6W (2-pole) per pole
Allowable Operation Temperature	-25 °C to 70 °C	Power Acceptance @ Ta > 23°C	Admissible power acceptance at higher ambient temperature see derating curves
IP-Protection	front side IP40 acc. to IEC 60529	Voltage Selector	optional, step, 2-4 digits
Protection against electric shock	Suitable for appliances with protection class I acc. to IEC 61140		
Terminal	Quick connect terminals 4.8 x 0.8 mm		
Panel Thickness S	Screw: max 8 mm Mounting screw torque max 0.5Nm Snap-in: 1.5/2/2.5 mm		
Material: Housing	Thermoplastic, black, UL 94V-0		

Approvals and Compliances



Detailed information on product approvals, code requirements, usage instructions and detailed test conditions can be looked up in [Details about Approvals](#)

SCHURTER products are designed for use in industrial environments. They have approvals from independent testing bodies according to national and international standards. Products with specific characteristics and requirements such as required in the automotive sector according to IATF 16949, medical technology according to ISO 13485 or in the aerospace industry can be offered exclusively with customer-specific, individual agreements by SCHURTER.

Approvals





The approval mark is used by the testing authorities to certify compliance with the safety requirements placed on electronic products.

Approval Reference Type: KEA

Approval Logo	Certificates	Certification Body	Description
	VDE Approvals	VDE	Certificate Number: 40046508
	UL Approvals	UL	UR File Number: E93617
	CCC Approvals	CCC	CCC Certificate Number: 2017180204004083



Product standards

Product standards that are referenced

Organization	Design	Standard	Description
	Designed according to	IEC 60320-1	Appliance couplers for household and similar general purposes
	Designed according to	IEC 60127-6	Miniature fuses. Part 6. Fuse-holders for miniature fuse-links
	Designed according to	UL 498	Standard for Attachment Plugs and Receptacles
	Designed according to	CSA C22.2 no. 42	General Use Receptacles, Attachment Plugs, and Similar Wiring Devices









Application standards

Application standards where the product can be used

Organization	Design	Standard	Description
	Suitable for applications acc.	IEC/UL 62368-1	Audio/video, information and communication technology equipment - Part 1: Safety requirements
	Suitable for applications acc.	IEC 60601-1	Medical electrical equipment - Part 1: General requirements for basic safety and essential performance
	Suitable for applications acc.	IEC 60335-1	Safety of electrical appliances for household and similar purposes. Meets the requirements for appliances in unattended use. This includes the enhanced requirements of glow wire tests acc. to IEC 60695-2-11 or -12 & -13.

Compliances

The product complies with following Guide Lines

Identification	Details	Initiator	Description
	CE declaration of conformity	SCHURTER AG	The CE marking declares that the product complies with the applicable requirements laid down in the harmonisation of Community legislation on its affixing in accordance with EU Regulation 765/2008.
	UKCA declaration of conformity	SCHURTER AG	The UKCA marking declares that the product complies with the applicable requirements laid down in the British Amendment of Regulation (EC) 765/2008.
	RoHS	SCHURTER AG	Directive RoHS 2011/65/EU, Amendment (EU) 2015/863
	China RoHS	SCHURTER AG	The law SJ / T 11363-2006 (China RoHS) has been in force since 1 March 2007. It is similar to the EU directive RoHS.
	REACH	SCHURTER AG	On 1 June 2007, Regulation (EC) No 1907/2006 on the Registration, Evaluation, Authorization and Restriction of Chemicals 1 (abbreviated as "REACH") entered into force.
		SCHURTER AG	V-Lock system are based on a matching plug-dose combination. The connector is equipped with a notch intended for use with the latching cordset. The cord latching system prevents against accidental removal of the cordset.
	White Paper Glow wire test	SCHURTER AG	Meets the requirements of IEC 60335-1 for appliances in unattended use. This includes the enhanced requirements of glow wire tests acc. to IEC 60695-2-11 or -12 & -13.
	Medical Equipment	SCHURTER AG	Suitable for use in medical equipment according to IEC/UL 60601-1 (1 MOOP, 1 MOPP)

Dimensions [mm]

Screw-on mounting type KEA

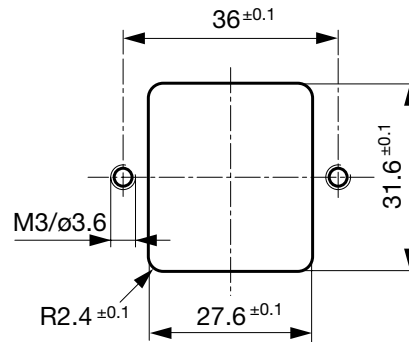
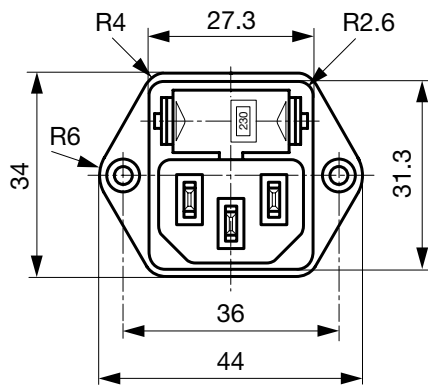
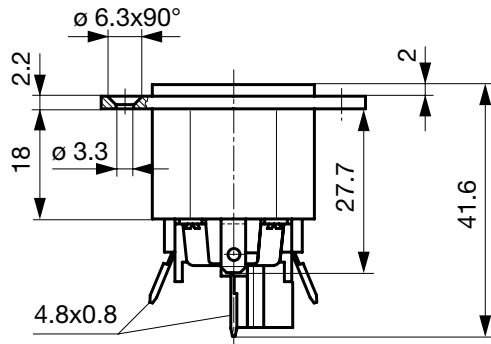

Snap-in mounting type KEA

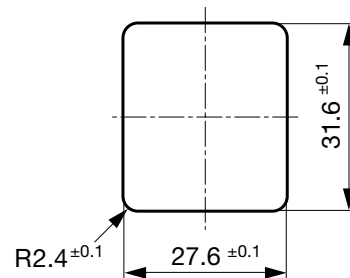
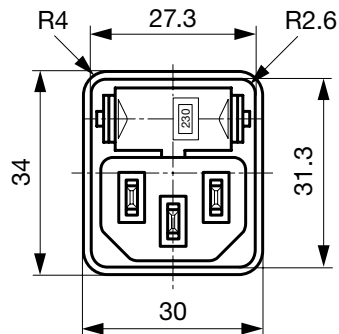
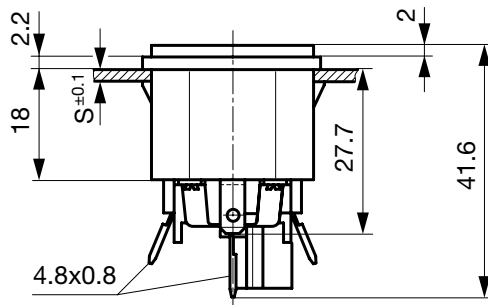

Diagrams

without conn.
Voltage Selector
4-positions, 1-pole

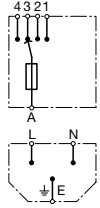

without conn.
Voltage Selector
4-positions, 2-pole

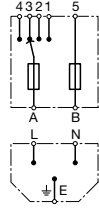

with internal connections
Voltage Selector
3-positions, 1-pole



with internal connections
Voltage Selector
3-positions, 2-pole

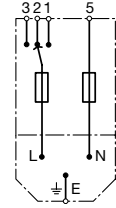

Voltage Selector
2 pos.
1-pole



Voltage Selector
2 pos.
2-pole



without voltage selector
1-pole

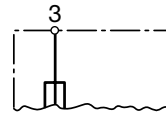

without voltage selector
2-pole

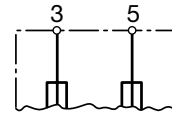

Derating Curves

1-pole

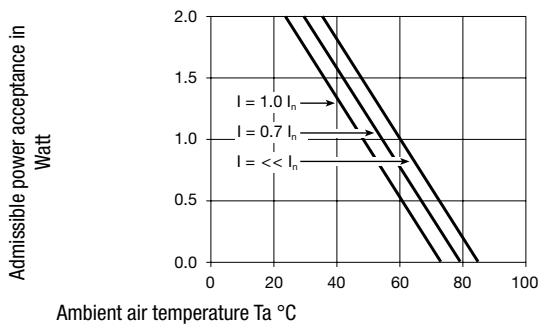

2-pole

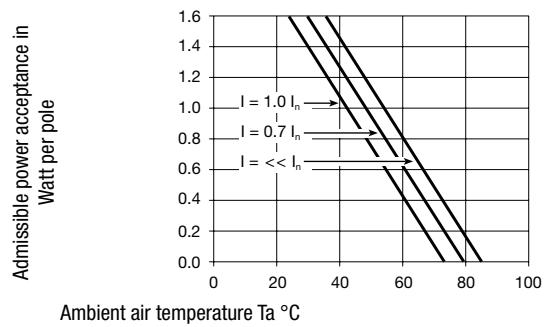

All Variants

Type	Panel mounting	Panel Thickness s [mm]	Fuseholder	Voltage Selector	Internally wired	Order Number
KEA	Snap-in	1.5	1-pole	-	●	4301.0522
KEA	Snap-in	2	1-pole	-	●	4301.0523
KEA	Snap-in	2.5	1-pole	-	●	4301.0524
KEA	Snap-in	1.5	1-pole	-		4301.2022
KEA	Snap-in	2	1-pole	-		4301.2023
KEA	Snap-in	2.5	1-pole	-		4301.2024
KEA	Snap-in	1.5	1-pole	2 pos.		4301.2142
KEA	Snap-in	2	1-pole	2 pos.		4301.2143
KEA	Snap-in	1.5	1-pole	3 pos.	●	4301.0022
KEA	Snap-in	2	1-pole	3 pos.	●	4301.0023
KEA	Snap-in	2.5	1-pole	3 pos.	●	4301.0024
KEA	Snap-in	1.5	1-pole	3/4 digits		4301.2062
KEA	Snap-in	2	1-pole	3/4 digits		4301.2063
KEA	Snap-in	2.5	1-pole	3/4 digits		4301.2064
KEA	Snap-in	1.5	2-pole	-	●	4301.0502
KEA	Snap-in	2	2-pole	-	●	4301.0503
KEA	Snap-in	2.5	2-pole	-	●	4301.0504
KEA	Snap-in	1.5	2-pole	-		4301.2002
KEA	Snap-in	2	2-pole	-		4301.2003
KEA	Snap-in	2.5	2-pole	-		4301.2004

Type	Panel mounting	Panel Thickness s [mm]	Fuseholder	Voltage Selector	Internally wired	Order Number
KEA	Snap-in	1.5	2-pole	2 pos.		4301.2122
KEA	Snap-in	2	2-pole	2 pos.		4301.2123
KEA	Snap-in	2.5	2-pole	2 pos.		4301.2124
KEA	Snap-in	1.5	2-pole	3 pos.	●	4301.0002
KEA	Snap-in	2	2-pole	3 pos.	●	4301.0003
KEA	Snap-in	2.5	2-pole	3 pos.	●	4301.0004
KEA	Snap-in	1.5	2-pole	3/4 digits		4301.2042
KEA	Snap-in	2	2-pole	3/4 digits		4301.2043
KEA	Snap-in	2.5	2-pole	3/4 digits		4301.2044
KEA	Screw	-	1-pole	-	●	4301.0521
KEA	Screw	-	1-pole	-		4301.2021
KEA	Screw	-	1-pole	2 pos.		4301.2141
KEA	Screw	-	1-pole	3 pos.	●	4301.0021
KEA	Screw	-	1-pole	3/4 digits		4301.2061
KEA	Screw	-	2-pole	-	●	4301.0501
KEA	Screw	-	2-pole	-		4301.2001
KEA	Screw	-	2-pole	2 pos.		4301.2121
KEA	Screw	-	2-pole	3 pos.	●	4301.0001
KEA	Screw	-	2-pole	3/4 digits		4301.2041

Most Popular.

Availability for all products can be searched real-time: <https://www.schurter.com/en/info-center/support-tools/stock-check-distributors>

The fuse drawer is not included and must be ordered separately (see required accessory).

Packaging unit	50 Pcs
-----------------------	--------

Required Accessory

Description

Fusedrawer_2

Fusedrawer for Fuse Links 5x20 mm, with or without Voltage Selector Insert



Fingergrip-Safe, 2-pole	3-104-672
Fingergrip, 2-pole, Voltage Selector, 110, 150, 220	4301.1014.01
Fingergrip, 2-pole, Voltage Selector, 120, 240	4301.1014.02
Fingergrip, 2-pole, Voltage Selector, 110, 220	4301.1014.03
...	...

Accessories



Wire_Harness

Wire harness for SCHURTER products



Assorted_Covers

Rear Cover

0859.0047



RC320
 Rear Cover for Power Entry Module



Cord_retaining_kits
 Cord retaining strain relief

Flat head, A	4700.0001
Countersunk, B	4700.0002

Mating Outlets/Connectors

Category / Description

[Appliance Outlet Overview complete](#)



4787, Mounting: Screw-on mounting, Appliance Outlet: IEC Solder terminals, 10 A, Suitable for appliances with protection class I	4787
4788, Mounting: Snap-in version, Appliance Outlet: IEC Solder / Quick Connect, 10 A, Suitable for appliances with protection class I	4788
IEC Appliance Outlet F or H, Screw-on Mounting, Front Side, Solder, PCB or Quick-connect Terminal	5091

[Connector Overview complete](#)



4782 Mounting: Power Cord, 3 x 1 mm ² / 3 x 18 AWG, Cable, Connector: IEC C13	4782
4785 Mounting: Power Cord, 3 x 1 mm ² / 3 x 18 AWG, Cable, Connector: IEC C13	4785
4300-06 Mounting: Power Cord, 3 x 1 mm ² / 3 x 18 AWG, Cable, Connector: IEC C13	4300-06
4781 Mounting: Power Cord, Cable, Connector: IEC C15	4781
4784 Mounting: Power Cord, 3 x 1 mm ² / 3 x 18 AWG, Cable, Connector: IEC C15	4784

Mating Outlets/Connectors shuttered

[Connector Overview complete](#)



4783 Mounting: Power Cord, 3 x 1 mm ² / 3 x 18 AWG, Cable, Connector: IEC C13	4783
--	------

[Power Cord Overview complete](#)



VAC13KS, Overview, V-Lock cord retaining, diverse Connector IEC C13, diverse, black	VAC13KS
VAC17KS, V-Lock cord retaining, diverse m, Connector IEC C17, diverse, black / grey / white	VAC17KS